

NOT: 3208

## Alarme

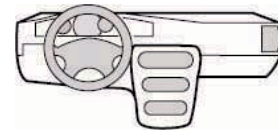

Réf.: 16 128 000 80

FR NOTICE DE POSE A USAGE PROFESSIONNEL / LES PHOTOS ET LES DESSINS NE SONT PAS CONTRACTUELS  
 GB FITTING INSTRUCTIONS FOR PROFESSIONAL FITTERS / PICTURES AND DRAWINGS ARE NOT CONTRACTUAL  
 ES INSTRUCCIONES DE MONTAJE PARA USO PROFESIONAL / LAS FOTOGRAFIAS Y LOS DIBUJOS NO SON CONTRACTUALES  
 P MANUAL DE MONTAGEM PARA UTILIZACÃO PROFISSIONAL / AS FOTOGRAFIAS E OS DESENHOS NAO SAO CONTRATUAIS  
 DE MONTAGEANLEITUNG FÜR PROFESSIONNELLEN EINSATZ / DIE FOTOS UND DIE ZEICHNUNGEN SIND NICHT VERTRAGLICH  
 IT ISTRUZIONI DI POSA AD USO PROFESSIONALE / LE FOTOGRAFIE ED I DISEGNI NON SONO CONTRATTUALI  
 NL MONTAGEHANDLEIDING VOOR PROFESSIONEEL GEBRUIK / DE FOTO'S EN DE TEKENINGEN ZIJN NIET CONTRACTUEEL

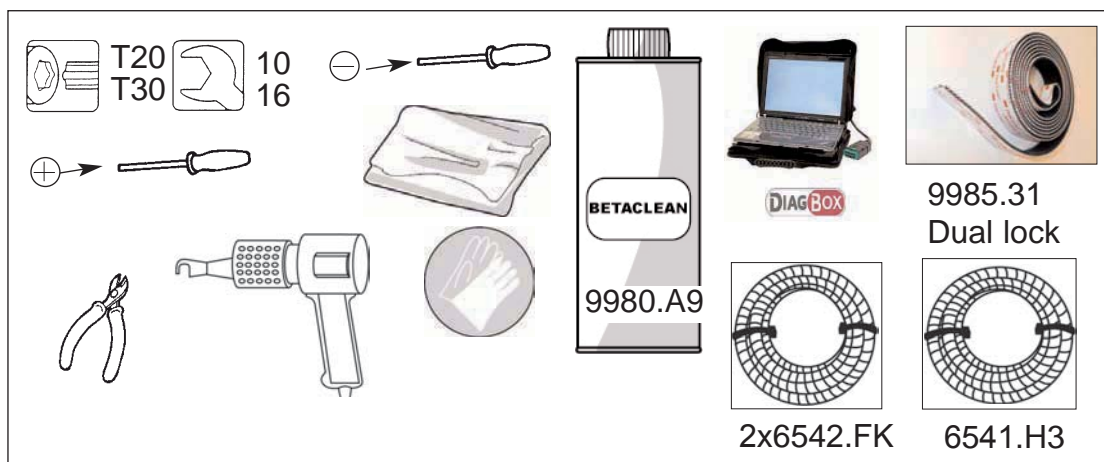
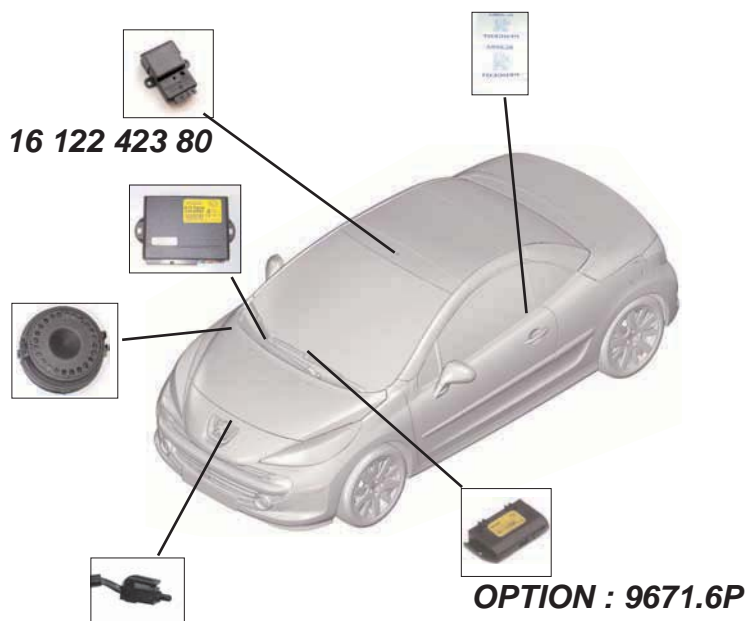

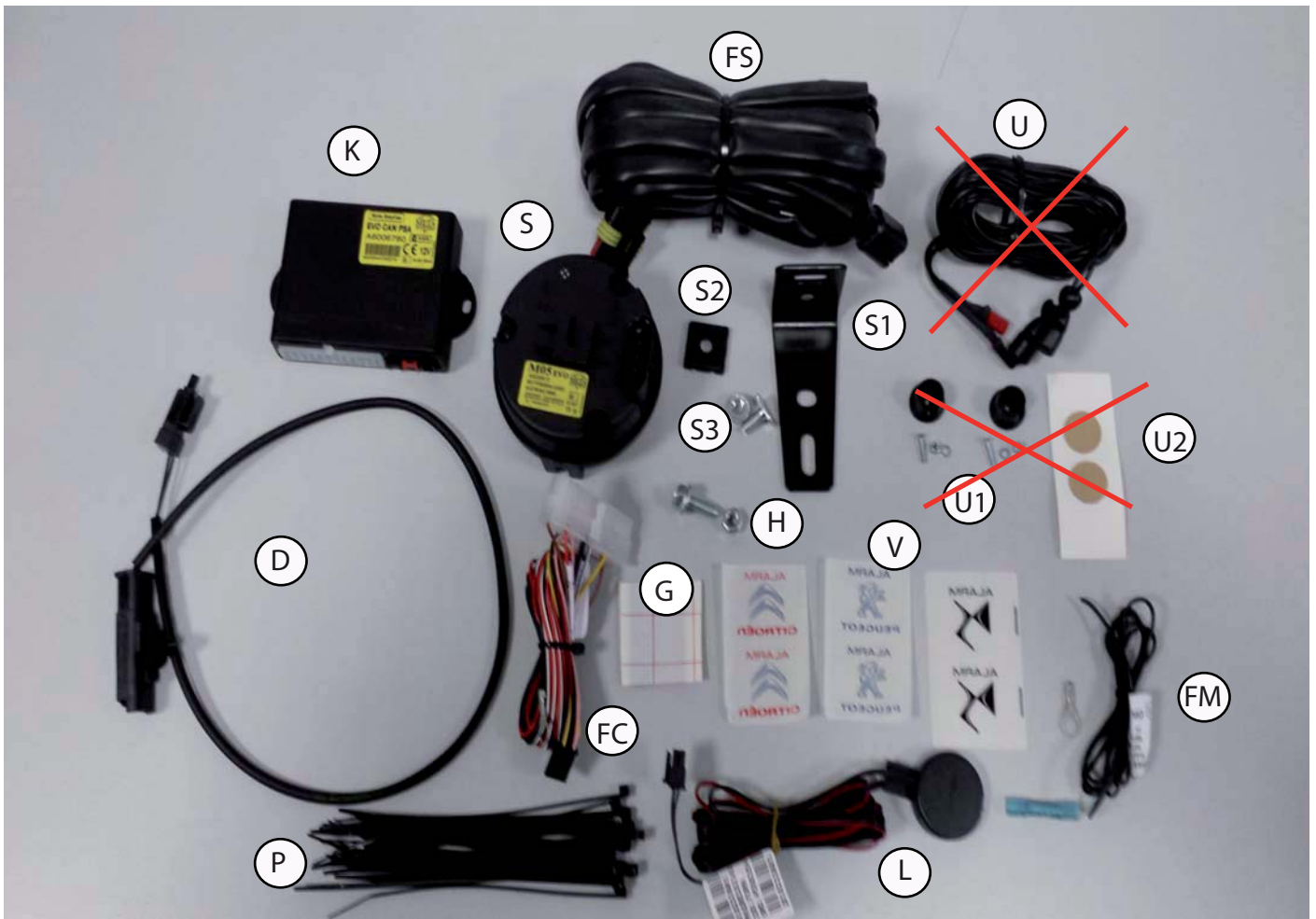

HF réf. 16 122 423 80



(N)

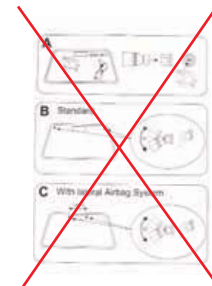

	F	GB	D	E	I	P	NL
BE	Bleu	Blue	Blau	Azul	Blu	Azul	Blauw
JN	Jaune	Yellow	Gelb	Amarillo	Giallo	Amarelo	Geel
BA	Blanc	White	Leertaste	Blanco	Bianco	Branco	Wit
NR	Noir	Black	Schwartz	Negro	Nero	Preto	Zwart
GR	Gris	Grey	Grau	Gris	Grigio	Cinzentos	Grijs
VE	Vert	Green	Grün	Verde	Verde	Verde	Groen
MR	Marron	Brown	Braun	Marron	Marrone	Castanho	Bruin
RG	Rouge	Red	Rot	Rojo	Rosso	Vermelho	Rood
BE/RG	Bleu/Rouge	Blue/Red	Blau/Rot	Azul/Rojo	Blu/Rosso	Azul/Vermelho	Blauw/Rood
RG/NR	Rouge/Noir	Red/Black	Rot/Schwartz	Rojo/Negro	Rosso/Nero	Vermelho/Preto	Rood/Zwart
VI/NR	Violet/Noir	Purple/Black	Violett/Schwartz	Violeta/Negro	Viola/Nero	Violeta/Preto	Paars/Zwart
VE/BE	Vert/Bleu	Green/Blue	Grün/Blau	Verde/Azul	Verde/Blu	Verde/Azul	Groen/Blauw
VI	Violet	Purple	Violett	Violeta	Viola	Violeta	Paars



1

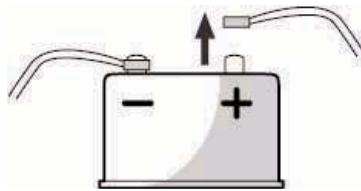

2

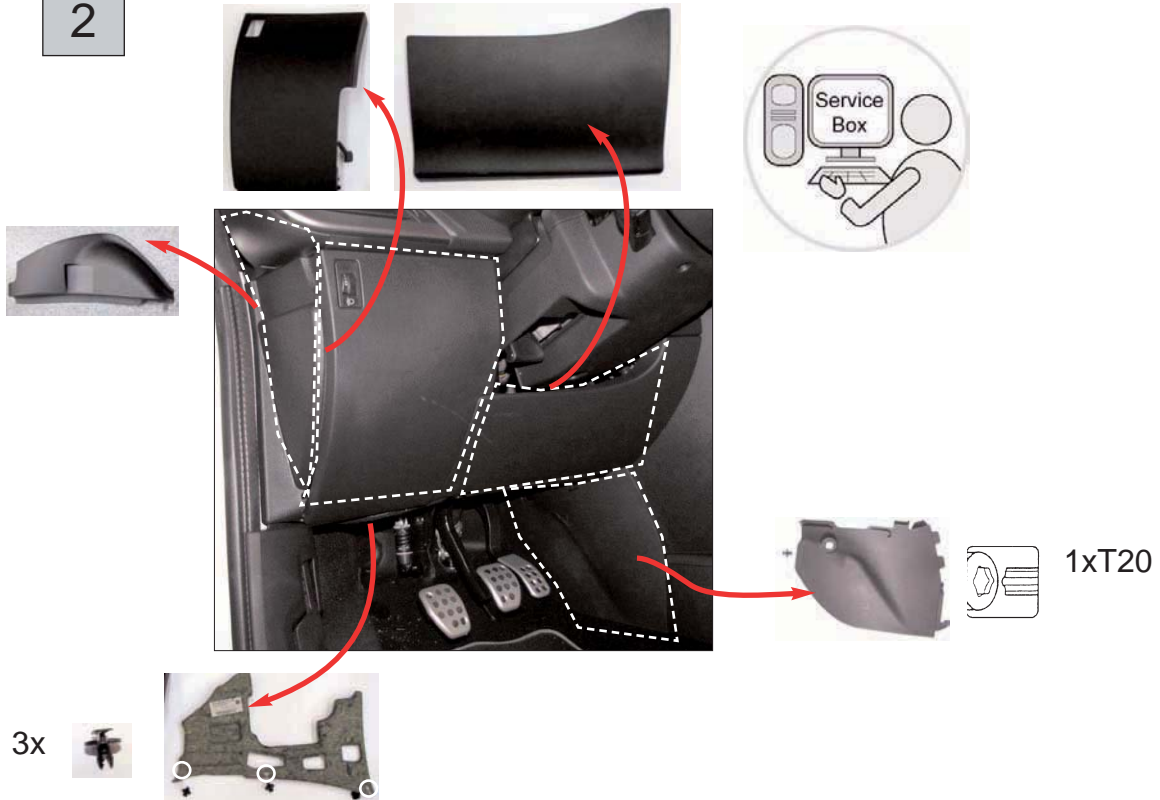

3



4



5

(H)



(S)

+

(S1) + (S2) + (S3)



10

(P)



6

(D)

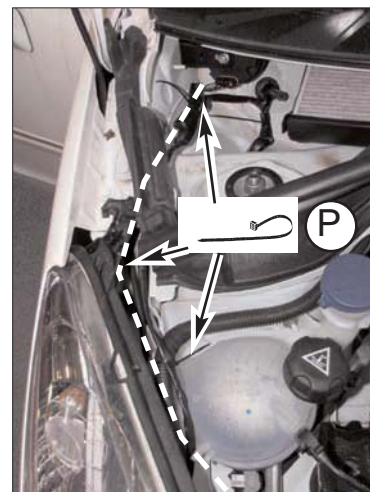
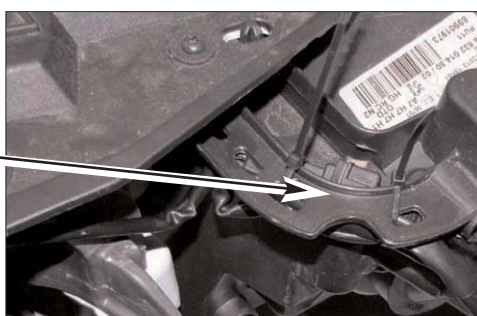
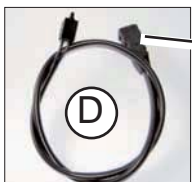

7

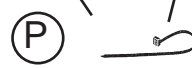
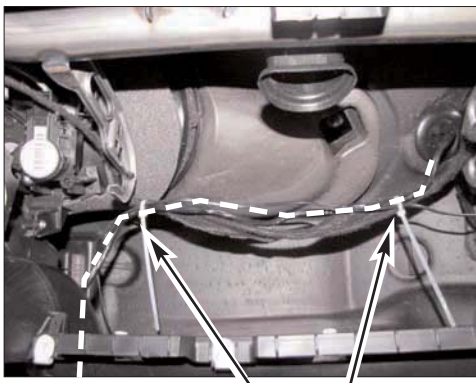

8

Prise EA - BSI

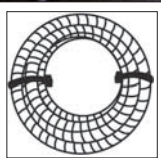
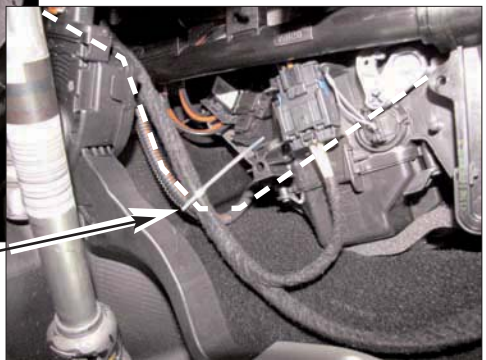
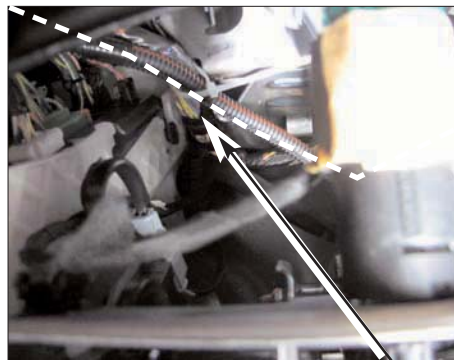
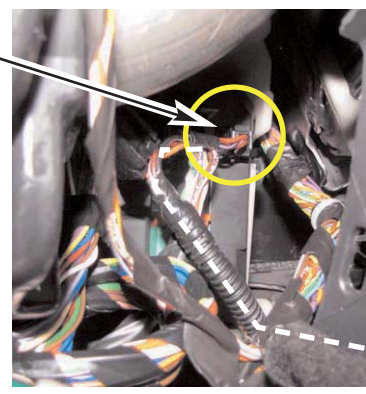
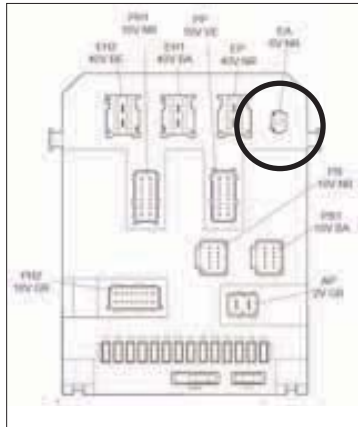

6542.FK 1200 mm

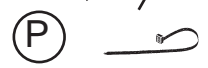

9



10

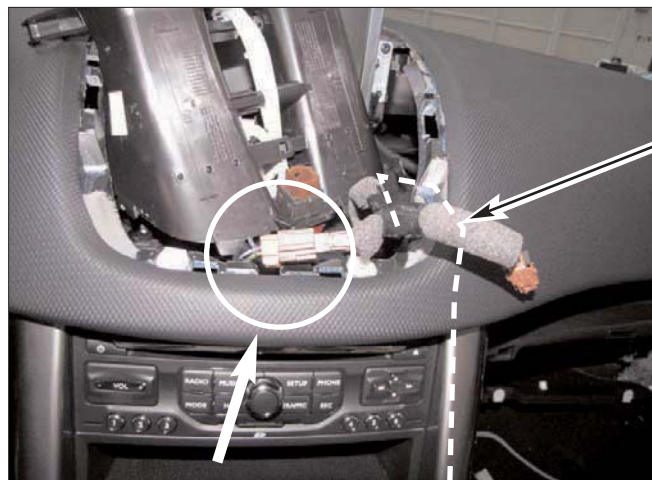
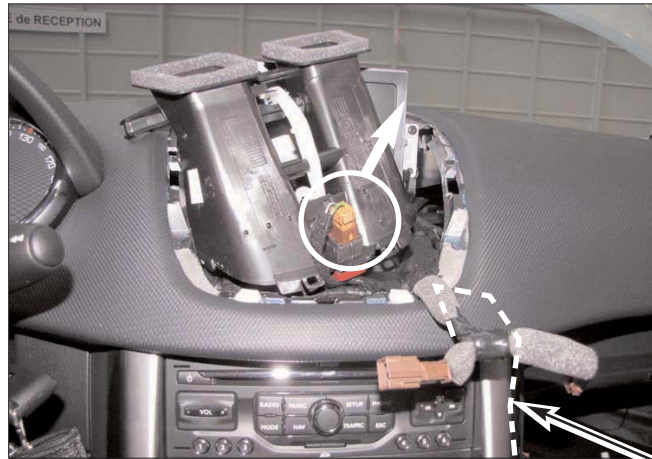

FC



11

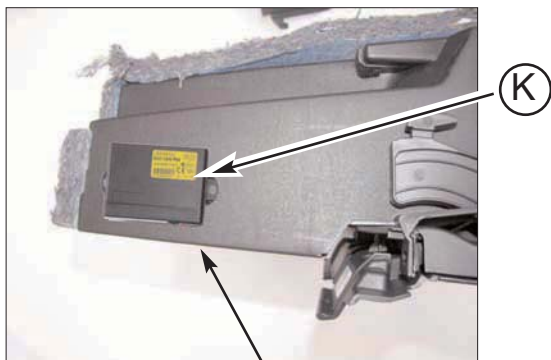

Dual lock  
9985.31

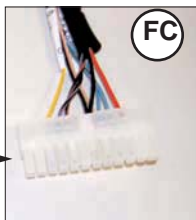
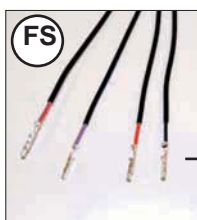

I

24	23	22	21	20	19	18	17	16	15	14	13
12	11	10	9	8	7	6	5	4	3	2	1

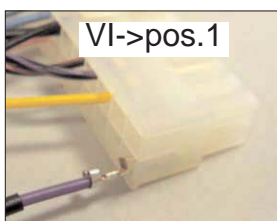

VI->pos.1



CLIC!

II

24	23	22	21	20	19	18	17	16	15	14	13
12	11	10	9	8	7	6	5	4	3	2	1



BE/RG->pos.13

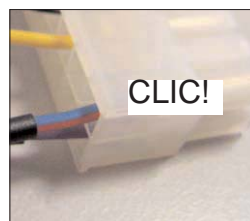

CLIC!

III

24	23	22	21	20	19	18	17	16	15	14	13
12	11	10	9	8	7	6	5	4	3	2	1



RG->pos.10



CLIC!

IV

24	23	22	21	20	19	18	17	16	15	14	13
12	11	10	9	8	7	6	5	4	3	2	1

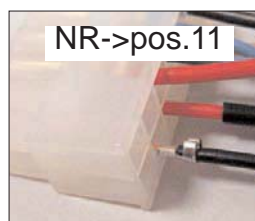

NR->pos.11

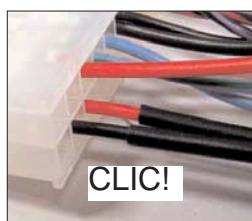

CLIC!

EVO CAN PSA

24	23	22	21	20	19	18	17	16	15	14	13
12	11	10	9	8	7	6	5	4	3	2	1

TxRx  
□ □ ⊕

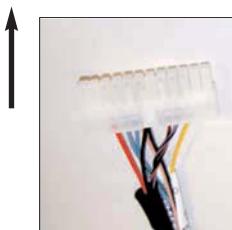



12

# MODULE HYPERFREQUENCE - 16 122 423 80



A



B

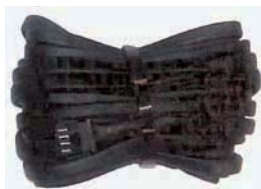

C



D



E



F



G

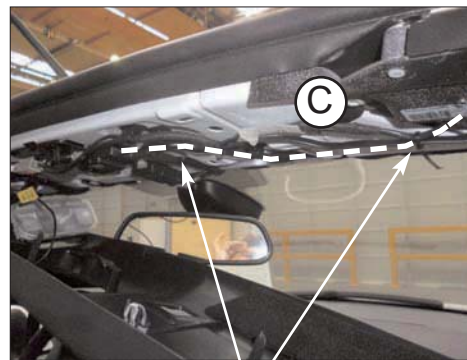
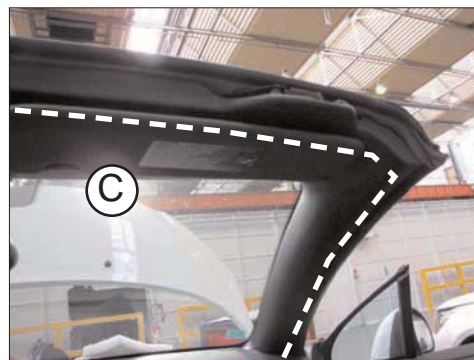
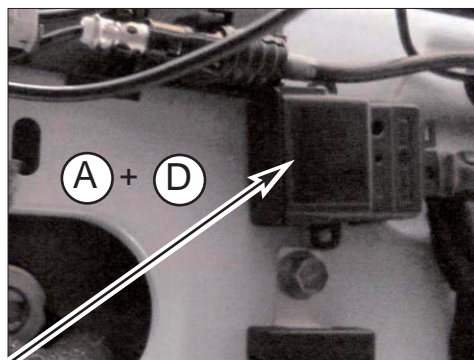
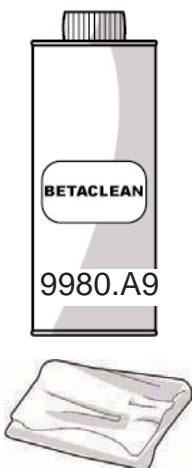

P

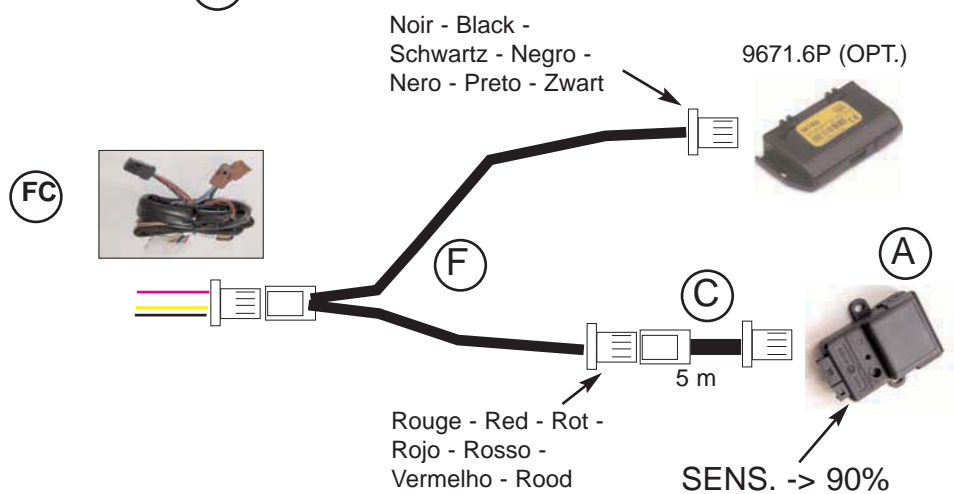

13

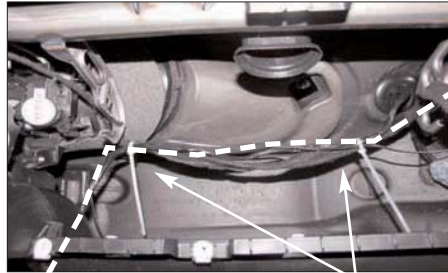
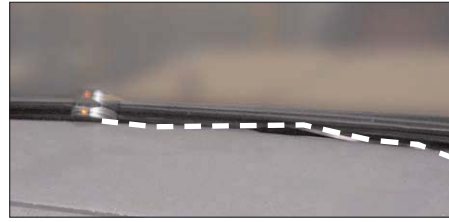
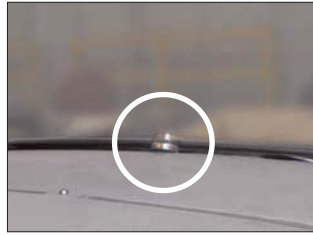
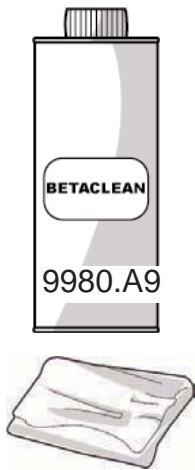

**EVO CAN PSA**

24	23	22	21	20	19	18	17	16	15	14	13	
12	11	10	9	8	7	6	5	4	3	2	1	TxRx
												+

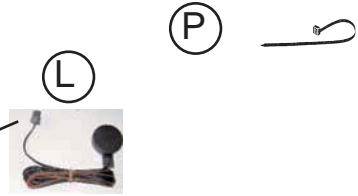

14

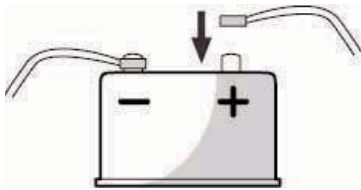

15

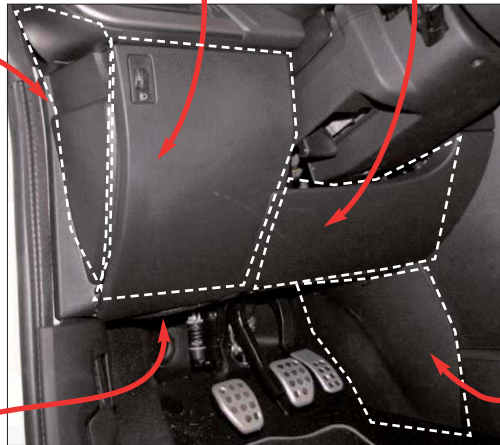
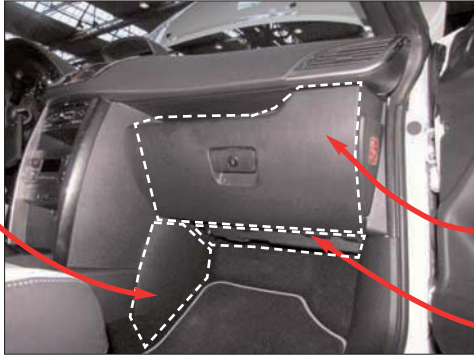

16

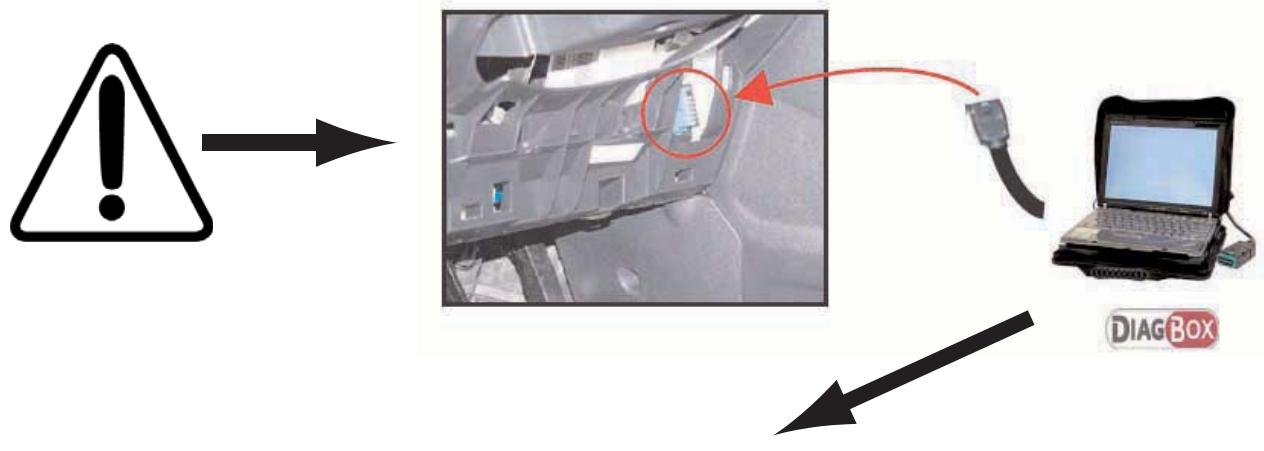

 NOT\_3304\_DIAGBOX\_ALARME\_CAN.pdf

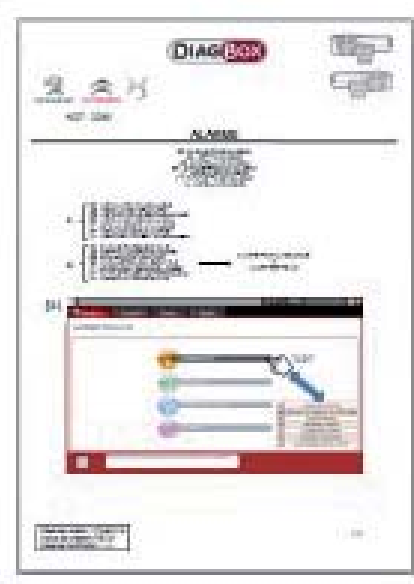

# TEST

17

A

A1

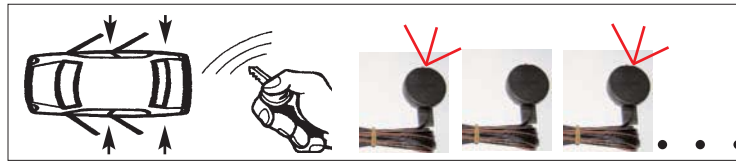

A2

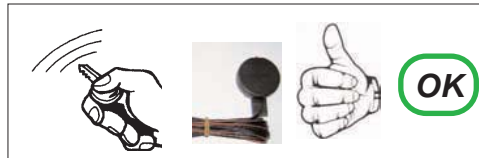

B

B1

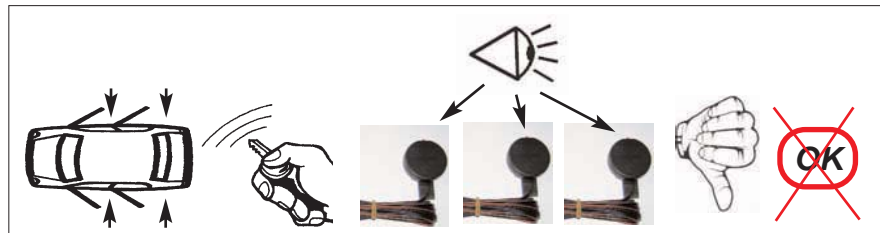

B2

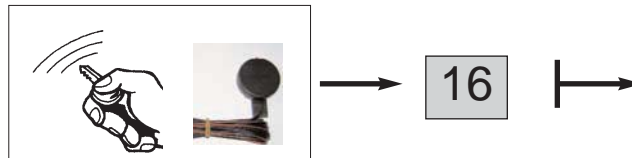

C

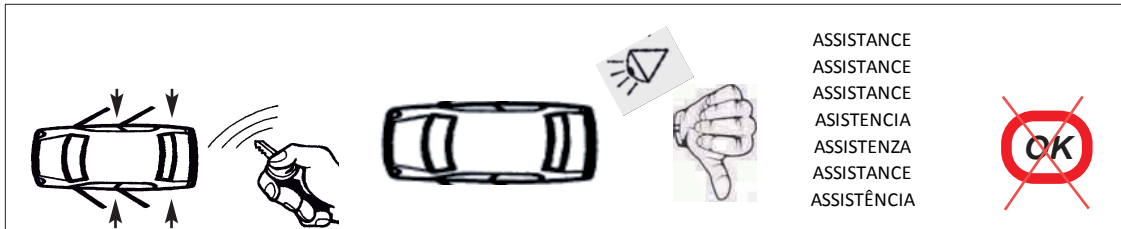

18

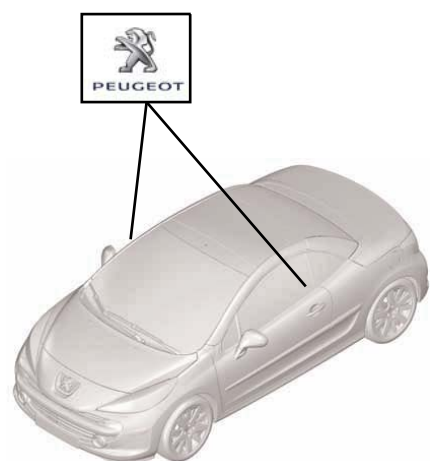

19

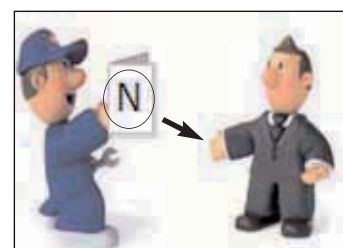

# OPTION - MODULE ANTI-SOULEVEMENT - 9671.6P

20

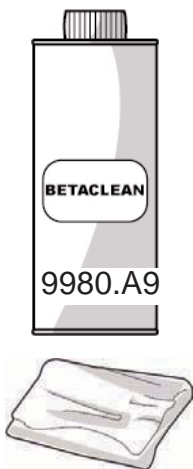

(P) 



(FC)

